

## WG 25

For powering intrinsically safe 2-wire transmitters and SMART transmitters.

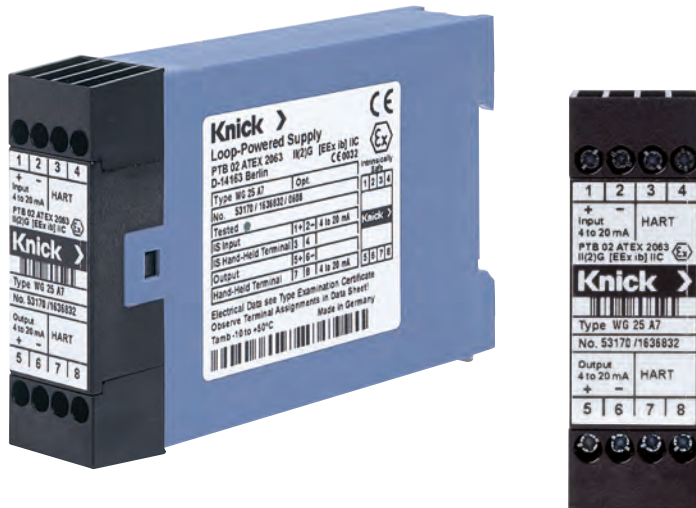

### The Task

The passive WG 25 repeater power supply is loop-powered. It is used for galvanic hazardous-area separation of a 2-wire supply line and transmits both 4 ... 20 mA and HART signals in both directions. With a voltage drop of just 4.2 V, the WG 25 uses the supply optimally so that all common 2-wire transmitters can be connected.

### The Advantages

Compared with active repeater power supplies, it has considerable price and reliability advantages.

Multi-channel systems, for example, require only one central, safe-area power supply that does not even need protective separation.

### The Technology

Using Knick TransShield technology, the WG 25 has specifications that were previously not available in passive repeater power supplies:

- Extremely high reliability, MTTF of over 300 years
- Protective separation, transient protection
- 10 kV test voltage (optional)
- High electromagnetic compatibility
- Extremely low residual ripple and common-mode interference
- Outstanding pulse formation
- HART transmission
- Hazardous/safe area separation

# WG 25

## Facts and Features

- **Affordable**  
Good price due to omission of integrated power supply
- **No mains supply required**  
Cost savings due to lower wiring effort, no mains influences
- **Low power losses**  
No unnecessary heating in the enclosure
- **Protective separation**  
according to EN 61140  
Protection of maintenance staff and downstream devices against excessively high voltages
- **HART transmission**  
Bidirectional point-to-point transmission of digital data according to the HART specification
- **EMC tested**  
RFI suppressed and surge proof, reliable operation even with electromagnetic interference
- **Maximum reliability**  
No maintenance work, therefore the related costs are not incurred
- **5-year warranty**

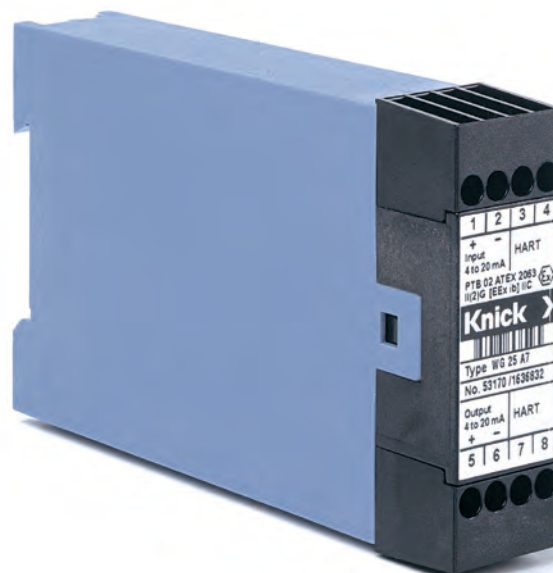

**Product Line**

**Devices**

WG 25

**Order no.**

**WG 25 A7**

**Power supply**

None, supply from input signal

**Options**

Increased test voltage 10 kV AC

**Order no.**

**471**

**Specifications**

**Input data**

Input (current loop)

4 ... 20 mA (transmission possible up to 22 mA), intrinsically safe

Supply voltage

≥ 17 V, short-circuit proof, see "Supply voltage" diagram

Min. operating current

< 1 mA

Input short-circuit current

≤ 28 mA

Voltage drop

< 4.2 V at 20 mA and supply ≤ 20 V, see "Supply voltage" diagram

**Output data**

Output

4 ... 20 mA, 1:1 transmission (22 mA)

Overload capacity

50 mA, 30 V (corresponds to a 600-ohm load)

Offset

< 20 μA

Residual ripple  $V_{rms}$

< 1.5 mV/mA

**Transmission behavior**

Transmission error

0.2 % meas. val.

Supply voltage influence

< 15 μA/V

HART attenuation

< 10 dB

**Isolation**

Test voltage

4.4 kV AC  
10 kV AC with option 471

Working voltages  
(basic insulation)

1000 V AC/DC, with overvoltage category II and pollution degree 2 according to EN 61010-1  
For applications with high working voltages, take measures to prevent accidental contact and make sure that there is sufficient distance or insulation between adjacent devices.  
Allowable working voltage for other overvoltage categories and pollution degrees on request.  
The maximum working voltage for use in hazardous areas is 250 V.

Protection against electric shock

Protective separation to EN 61140 by reinforced insulation according to EN 61010-1.  
Up to 600 V AC/DC working voltage with overvoltage category II and pollution degree 2  
For applications with high working voltages, take measures to prevent accidental contact and make sure that there is sufficient distance or insulation between adjacent devices.  
The maximum working voltage for use in hazardous areas is 250 V.

## WG 25

### Specifications (continued)

#### Standards and approvals

|                      |   |
|----------------------|---|
| Explosion protection | II (2) G [EEx ib] IIC PTB 02 ATEX 2063<br>See certificates of conformity for further specifications |
| EMC                  | EN 61326-1, NAMUR NE 21   |
| RoHS conformity      | According to directive 2011/65/EU   |

#### Further data

|                     |   |
|---------------------|---|
| Ambient temperature | Operation: -10 ... +50 °C<br>Transport and storage: -30 ... +80 °C  |
| Ambient conditions  | Indoor use <sup>1)</sup><br>Relative humidity 5 ... 95 %, no condensation; max. altitude 2000 m (air pressure: 790 ... 1060 hPa) <sup>2)</sup>  |
| Design              | Modular housing, 22.5 mm wide, screw terminals; see dimension drawings for further measurements   |
| Tightening torque   | 0.6 Nm  |
| Ingress protection  | Housing: IP 40, terminals: IP 20  |
| Mounting            | With snap-on mounting for 35 mm DIN rail according to EN 60715  |
| Connection          | Captive terminal screws M 3 x 8 ; box-type terminals with self-raising wire protection,<br>max. conductor cross section:<br>1 x 4 mm <sup>2</sup> solid<br>1 x 2.5 mm <sup>2</sup> stranded with ferrule<br>2 x 1.5 mm <sup>2</sup> stranded with ferrule<br>Only trained and qualified personnel may perform installation, commissioning, and maintenance! |
| Weight              | Approx. 120 g   |

1) Closed, weather-protected operating areas (stationary operation), water and wind-driven precipitation (rain, snow, hail, etc.) excluded

2) Lower air pressure reduces the allowable working voltages.

**Supply Voltage Versus Supply**

Supply voltage at the 2-wire transmitter [V]

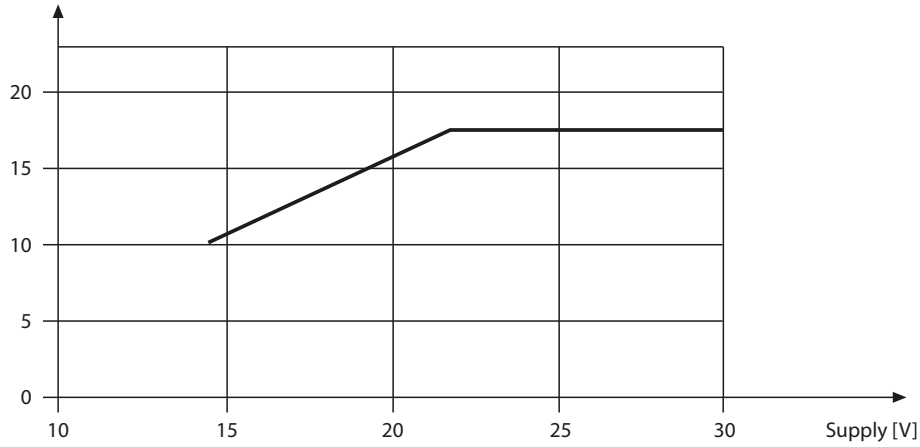

# WG 25

## Block Diagram

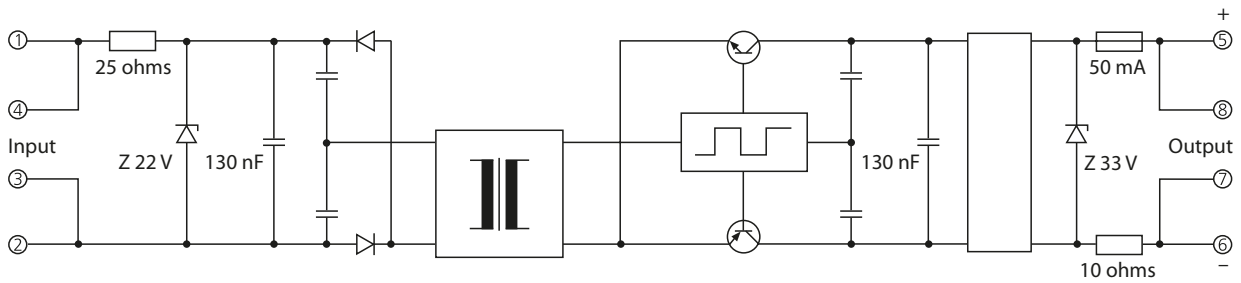

**Typical Applications**

**Without HART Communication**

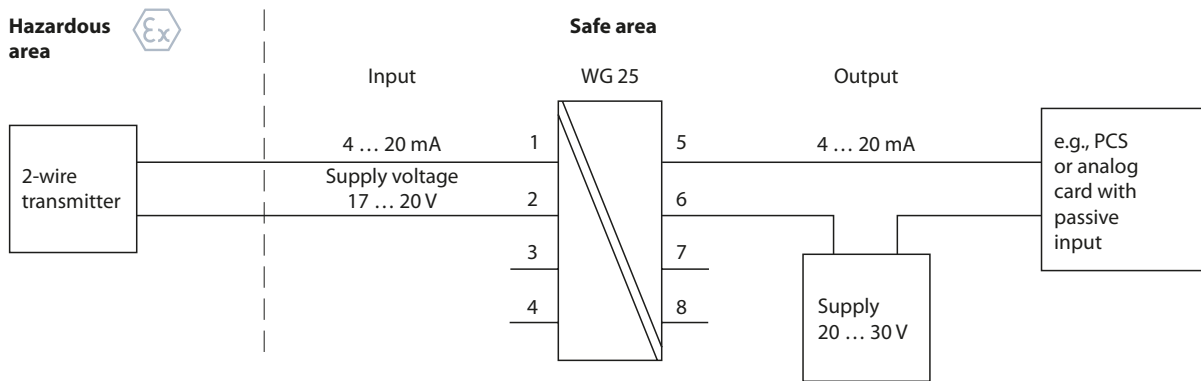

**With HART Communication**

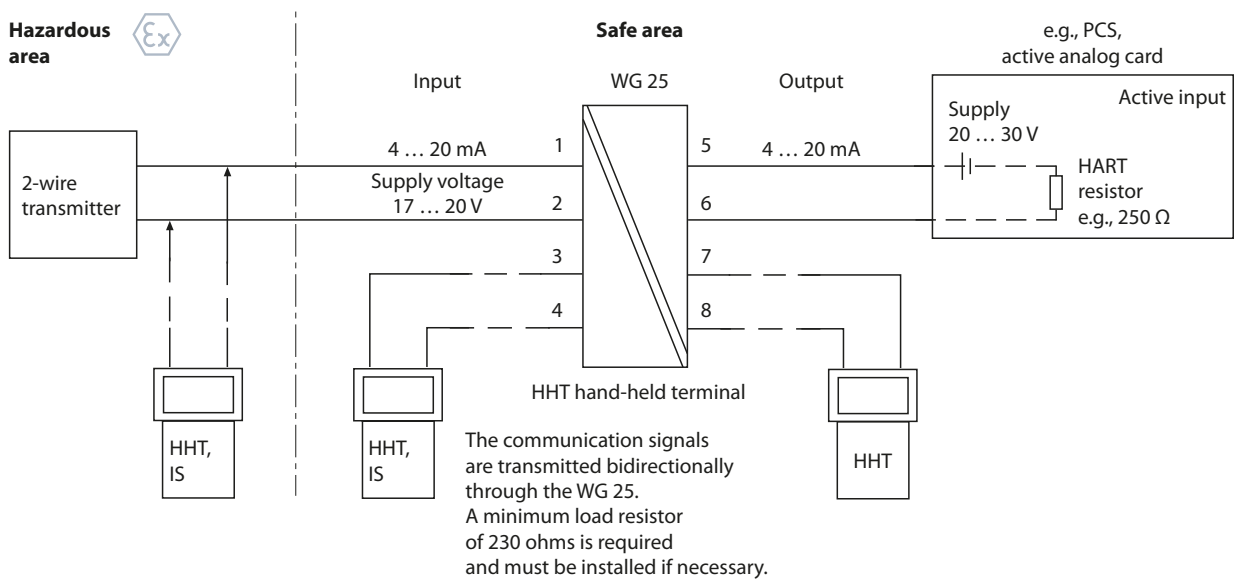

# WG 25

## Dimension Drawing and Terminal Assignments

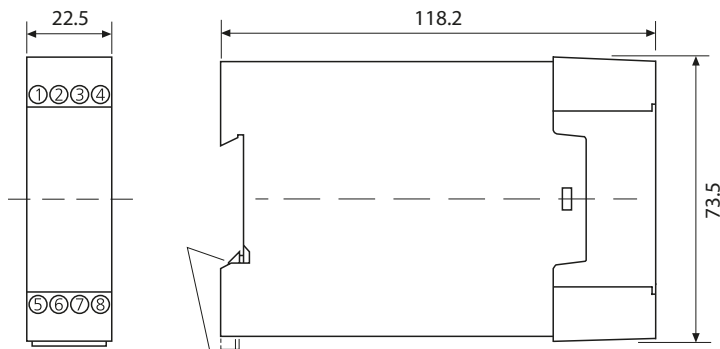

Snap-on mounting on 35 mm  
DIN rail to EN 60715

### Terminal assignments

- 1 Input +
- 2 Input -
- 3 HHT Ex
- 4 HHT Ex
- 5 Output +
- 6 Output -
- 7 HHT
- 8 HHT

Captive terminal screws M 3 x 8  
Box-type terminals with  
self-raising wire protection,  
max. conductor cross section:  
1 x 4 mm<sup>2</sup> solid  
1 x 2.5 mm<sup>2</sup> stranded with ferrule  
2 x 1.5 mm<sup>2</sup> stranded with ferrule

Only trained and qualified personnel may  
perform installation, commissioning, and  
maintenance!