

This brochure provides only an overview of our product range. If you would like more information please contact us.

Level controllers for all liquid applications

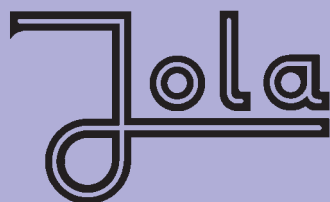
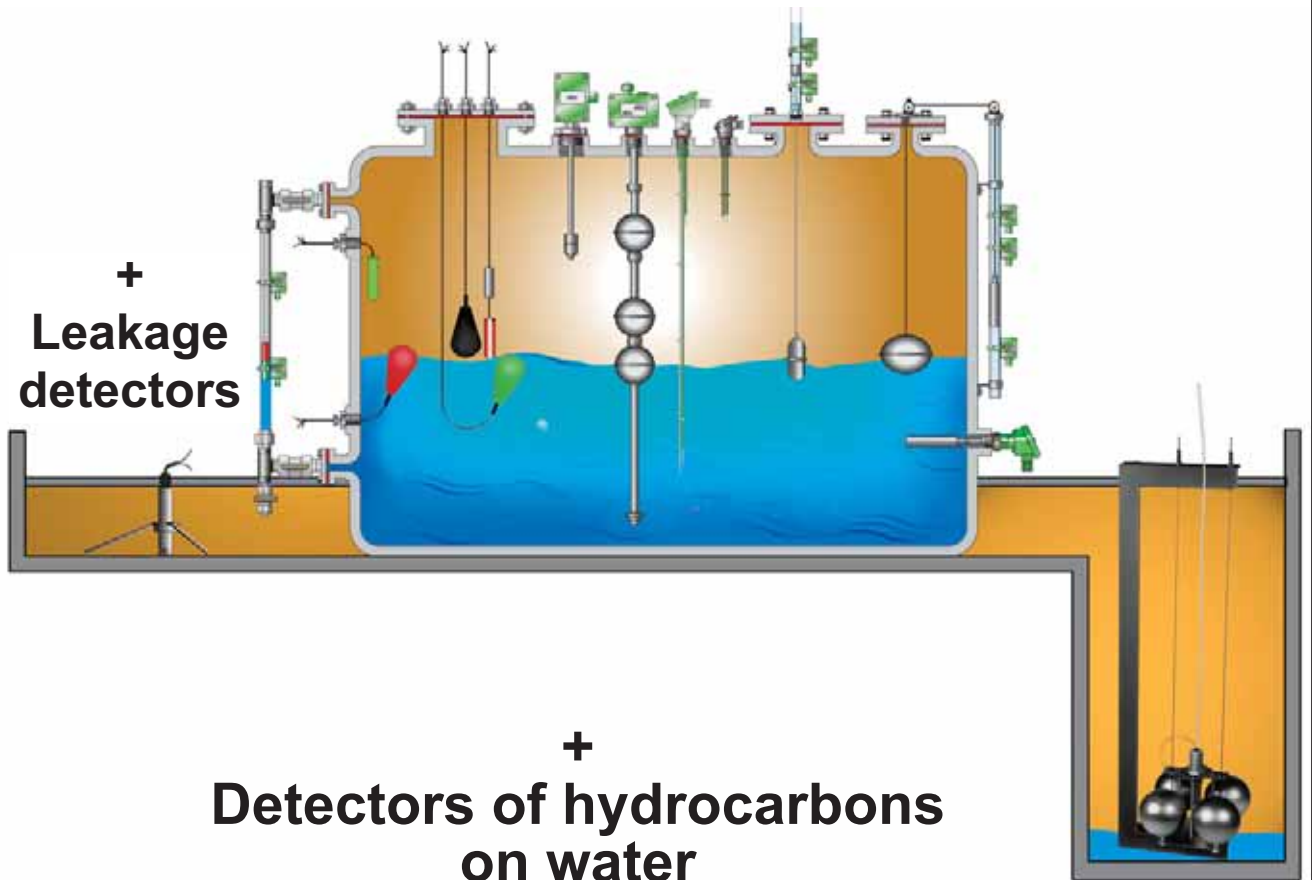

Jola Spezialschalter K. Mattil & Co. KG

Postfach 11 49 • D-67460 Lambrecht (Pfalz)
Klostergartenstraße 11-20 • D-67466 Lambrecht (Pfalz)
Telefon (06325) 188 - 01 • Telefax (06325) 6396
Internet-Adresse: <http://www.Jola-Info.de>
E-Mail-Adresse: Kontakt@Jola-Info.de

SSP... and SI/SSP/NL 1/K/... Variant 0 Ex I M2 / II 2 GD EEx ia I / IIB T6 mercury-free floating switches

These floating switches are designed for mounting from the side or from the top.

To ensure a correct switching, the cable must be fixed at the required height using a stuffing gland, for example, in the case of mounting from the side or using a fixing weight or a mounting pipe, for example, in the case of mounting from the top.

These units are not suitable for use in turbulent liquids (e.g. in stirrer tanks).

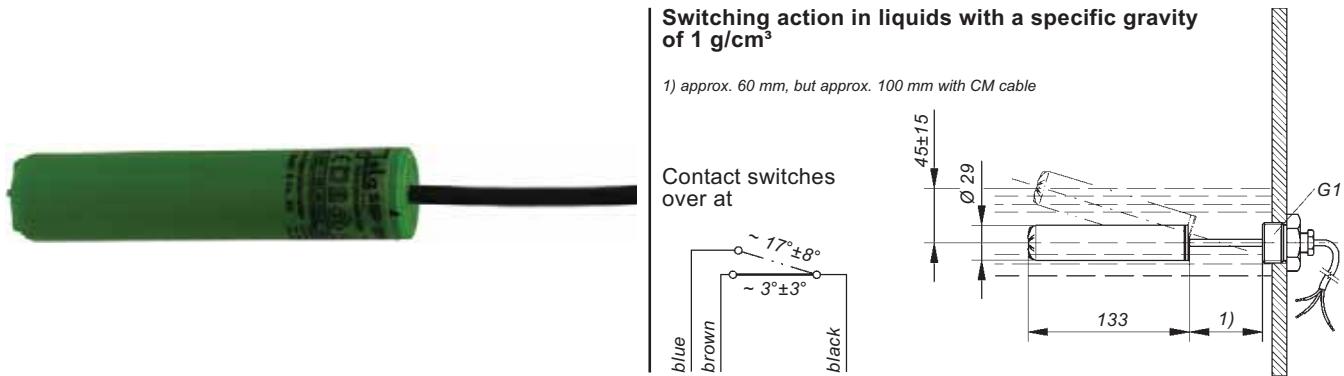

Technical data	SSP 3/K/... SSP/S3/K/...	SSP 1/K/... SSP/S1/K/...	SI/SSP/NL 1/K/... Variant 0 Ex I M2 / II 2 GD EEx ia I / IIB T6
Application	for standard applications	for light current applications	for use in intrinsically safe circuits in mines susceptible to firedamp or in potentially explosive atmospheres in categories zone 1, 21, 2 or 22; EC type examination certificate INERIS 03ATEX0149
Switching voltage	between AC/DC 24 V and AC/DC 250 V	between AC/DC 1 V and AC/DC 42 V	
Switching current	between AC 20 mA and AC 3 (1) A or between DC 20 mA and DC 100 mA	between AC 0.1 mA and AC 100 (50) mA or between DC 0.1 mA and DC 10 mA	
Switching capacity	max. 350 VA	max. 4 VA	
Operating principle	ball-operated microswitch, potential-free changeover contact		
Options for safety appl.	diodes (variant 1) or resistors (variant 2) on request		
Recommended applicat.	via Jola protection relay		
Float material	PP		
Seal material	FPM; on request: EPDM		
Float protection class	IP 68		
Max. immersion depth of float	max. 10 m head of water at + 20°C		
Connecting cable / applications / admissible temperature range	<p>– black PVC cable (for types: SSP ./K/PVC) or blue PVC cable (for types: SI/SSP/NL 1/K/PVC): for water, used water, slightly aggressive liquids, oils without aromatic additives, fuel oil and diesel fuel with a specific gravity $\geq 0.82 \text{ g/cm}^3$, in a temperature range from + 8°C to + 60°C</p> <p>– grey A05RN-F cable (for types: SSP ./K/RN and SI/SSP/NL 1/K/RN): for water, used water and slightly aggressive liquids with a specific gravity $\geq 0.82 \text{ g/cm}^3$, in a temperature range from 0°C to + 60°C</p> <p>– red-brown silicone cable (low mechanical strength) (for types: SSP/S./K/SIL and SI/SSP/NL 1/K/SIL): for water and certain other liquids with a specific gravity $\geq 0.82 \text{ g/cm}^3$ in a temperature range from 0°C to + 85°C for the types SSP/S./K/SIL and from 0°C to + 60°C for the type SI/SSP/NL 1/K/SIL</p> <p>– black CM cable (for types: SSP/S./K/CM and SI/SSP/NL 1/K/CM): for water and certain acids and lyes with a specific gravity $\geq 1 \text{ g/cm}^3$, in a temperature range from 0°C to + 85°C for the types SSP/S./K/CM and from 0°C to + 60°C for the type SI/SSP/NL 1/K/CM</p>		
Connecting cable length	1 m, other cable lengths on request.		
Optional extras	When ordering, please always state the desired cable length and cable type. stuffing glands (see below) and fixing weights $\text{Ø} 28 \text{ mm} \times 80 \text{ mm}$ high, made of brass, stainless steel 316 Ti or PP		stuffing glands and fixing weights made of brass, stainless steel 316 Ti or conductive PP

Optional extras:

- stuffing gland G^{3/8}, brass
- stuffing gland G^{1/2}, PP
- stuffing gland G^{1/2}, brass
- stuffing gland G^{1/2}, stainless steel 316 Ti
- stuffing gland G1, PP
- stuffing gland G1, brass
- stuffing gland G1, stainless steel 316 Ti

- } Floating switch mounting only possible from inside the tank
- } Floating switch mounting possible from outside the tank

Stuffing gland G1



SSX... and SI/SSX 1/K/... Variant 0 Ex I M2 / II 1 GD EEx ia I / IIC T6 mercury-free floating switches

These floating switches are designed for mounting from the side or from the top.

To ensure a correct switching, the cable must be fixed at the required height using a stuffing gland, for example, in the case of mounting from the side or using a fixing weight or a mounting pipe, for example, in the case of mounting from the top.

These units are not suitable for use in turbulent liquids (e.g. in stirrer tanks).

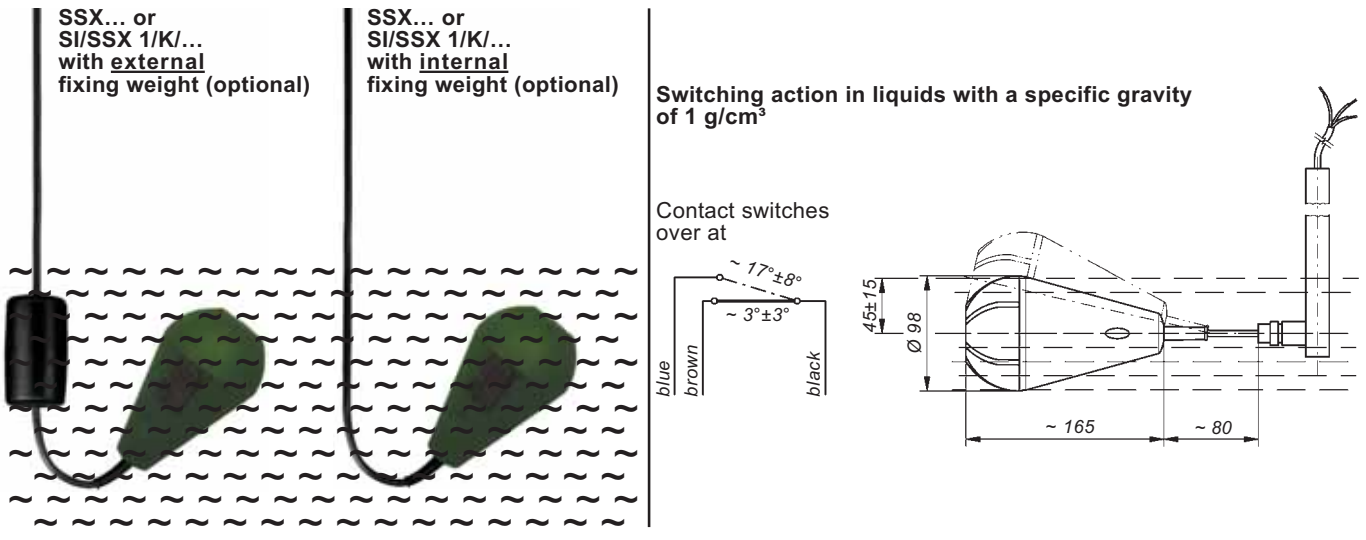

Technical data	SSX 3/K/... SSX/S3/K/...	SSX 1/K/... SSX/S1/K/...	SI/SSX 1/K/... Variant 0 Ex I M2 / II 1 GD EEx ia I / IIC T6
Application	for standard applications	for light current applications	for use in intrinsically safe circuits in mines susceptible to firedamp or in potentially explosive atmospheres in categories zone 0, 20, 1, 21, 2 or 22; EC type examination certificate INERIS 03ATEX0149
Switching voltage	between AC/DC 24 V and AC/DC 250 V	between AC/DC 1 V and AC/DC 42 V	
Switching current	between AC 20 mA and AC 3 (1) A or between DC 20 mA and DC 100 mA max. 350 VA	between AC 0.1 mA and AC 100 (50) mA or between DC 0.1 mA and DC 10 mA max. 4 VA	
Switching capacity			
Operating principle	ball-operated microswitch, potential-free changeover contact		
Options for safety appl.	diodes (variant 1) or resistors (variant 2) on request		
Recommended applicat.	via Jola protection relay		
Float material	PP		KR 5/Ex
Seal material		FPM; on request: EPDM	(info sheet on request)
Float protection class	IP 68		Ex I (M1) / II (1) GD [EEx ia] I / IIC
Max. immersion depth of float	max. 10 m head of water at + 20°C		
Connecting cable / applications / admissible temperature range	<ul style="list-style-type: none"> – black PVC cable (for types: SSX .K/PVC) or blue PVC cable (for types: SI/SSX 1/K/PVC): for water, used water, slightly aggressive liquids, oils without aromatic additives, fuel oil and diesel fuel with a specific gravity $\geq 0.8 \text{ g/cm}^3$, in a temperature range from + 8°C to + 60°C – green A05RN-F cable (for types: SSX .K/RN and SI/SSX 1/K/RN): for water, used water and slightly aggressive liquids with a specific gravity $\geq 0.8 \text{ g/cm}^3$, in a temperature range from 0°C to + 60°C – black CM cable (for types: SSX/S.K/CM and SI/SSX 1/K/CM): for water and certain acids and lyes with a specific gravity $\geq 0.8 \text{ g/cm}^3$, in a temperature range from 0°C to + 85°C for the types SSX/S.K/CM and from 0°C to + 60°C for the type SI/SSX 1/K/CM – white PTFE cable (for types: SSX/S.K/PTFE and SI/SSX 1/K/PTFE): suitable for all liquids in which the float material PP and the seal material FPM or EPDM are also resistant, with a specific gravity $\geq 0.8 \text{ g/cm}^3$, in a temperature range from 0°C to + 85°C for the types SSX/S.K/CM and from 0°C to + 60°C for the type SI/SSX 1/K/PTFE 		
Connecting cable length	2 m, other cable lengths on request.		
Optional extras	<p>When ordering, please always state the desired cable length and cable type.</p> <ul style="list-style-type: none"> – external fixing weight made of cast steel, $\varnothing 58 \text{ mm} \times 100 \text{ mm}$ high: for liquids with a specific gravity $\geq 0.8 \text{ g/cm}^3$ (not suitable for the PTFE cable) – external fixing weight made of stainless steel 316 Ti, $\varnothing 55 \text{ mm} \times 80 \text{ mm}$ high: for liquids with a specific gravity $\geq 0.8 \text{ g/cm}^3$ (not suitable for the PTFE cable) – internal fixing weight (integrated in the float): for liquids with a specific gravity between 0.95 and 1.05 g/cm^3 – external fixing weight made of conductive PP, $\varnothing 80 \text{ mm} \times 120 \text{ mm}$ high for liquids with a specific gravity $\geq 0.8 \text{ g/cm}^3$ 		

SS/PTFE 55/A 3/K and SS/PTFE 55/A 1/K mercury-free floating switches

These floating switches are designed for mounting from the top.

To ensure a correct switching, the cable must be fixed at the required height using for example a fixing weight or a mounting pipe.

These units are not suitable for use in turbulent liquids (e.g. in stirrer tanks).

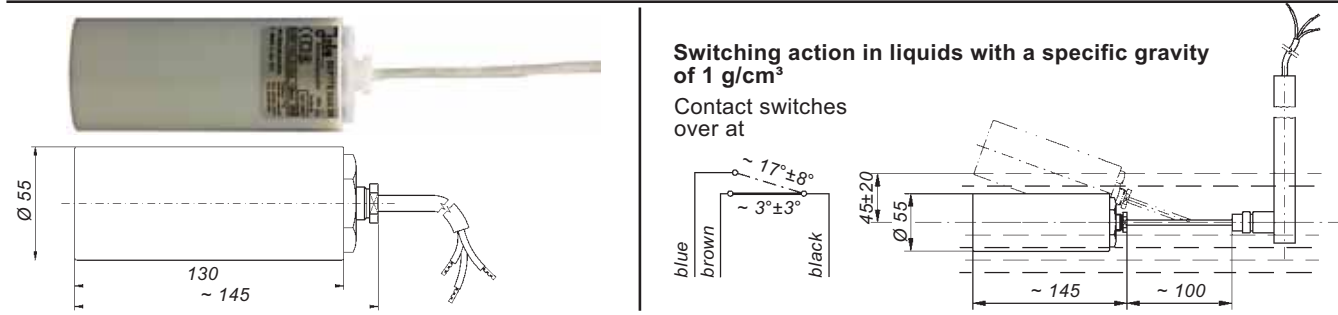

Technical data	SS/PTFE 55/A 3/K	SS/PTFE 55/A 1/K
Application	for standard applications	for light current applications
Switching voltage	between AC/DC 24 V and AC/DC 250 V	between AC/DC 1 V and AC/DC 42 V
Switching current	between AC 20 mA and AC 3 (1) A or between DC 20 mA and DC 100 mA	between AC 0.1 mA and AC 100 (50) mA or between DC 0.1 mA and DC 10 mA
Switching capacity	max. 350 VA	max. 4 VA
Operating principle	ball-operated microswitch, portential-free changeover contact	
Options for safety applications	—	diodes (= variant 1) or resistors (= variant 2) on req. via Jola protection relay KR ..
Recommended application	—	(info sheet on request)
Float material	PTFE	
Seal material	FPM	
Float protection class	IP 68	
Temperature application range	from 0°C to + 85°C	
Max. immersion depth of float	max. 3 m head of water at + 20°C	
Application range	in liquids with a specific gravity $\geq 1.0 \text{ g/cm}^3$	
Connecting cable	white PTFE cable, 3 x 0.75 mm ²	
Connecting cable length	2 m, other cable lengths on request. When ordering, please always state the desired cable length.	
Optional extra	fixing weight made of PTFE, $\varnothing 58 \text{ mm} \times 95 \text{ mm}$ high	

TS/O/... mercury-free immersion probes

These immersion probes consist of a probe tube on which one or several floating switches are mounted and of a terminal box to which the floating switches are connected.

These units are particularly suitable for fuel oil tanks, diesel-fired emergency power generators and hydraulic oil tanks.

These units are not suitable for use in turbulent liquids (e.g. in stirrer tanks).

Functional description based on a switching example: automatic filling of a tank

The bottom floating switch falls together with the liquid to the minimum level and acts on the contactor when it falls below the horizontal. Liquid is then pumped into the tank. When the maximum level is reached, the top floating switch rises above the horizontal, the contactor holding circuit is interrupted, and the filling process is stopped.

Technical data	TS/O/...
Probe tube material	PP
Probe tube diameter	see table below
Probe tube length	according to customer's specifications
Screw-in nipple (on request)	PP; flange on request
Terminal box	PP, A 307: 120 x 80 x 55 mm, protection class IP 65, for max. 12 terminals; for more than 12 terminals: polyester, A 113: 160 x 160 x 90 mm
Mounting orientation	vertical
Temperature application range	depends on the type of cable used, see page 1
Pressure resistance	for pressureless applications only
Mounted floating switches	SSP ... (exact type designation see page 1, please always state when ordering)
Electrical data	see page 1



Type designation	Number of mounted floating switches	Type of mounted floating switches	Probe tube diameter	Screw-in nipple (on request)
TS/O/1 x SSP ...	1	SSP ...	16 mm	G1 1/2 or G2
TS/O/2 x SSP ...	2		20 mm	G2
TS/O/3 x SSP ...	3		25 mm	G2
TS/O/4 x SSP ...	4		25 mm	G2
TS/O/5 x SSP ...	5		25 mm	G2

... = to be specified
The above equipment will be manufactured in accordance with customer's specifications.

On request:
- with more than 5 mounted floating switches,
- with adjustable screw-in nipple

When specifying the switching points of the immersion probes, please note that

- when the liquid level rises, the contact of the floating switches is not activated when the floating switches reach the horizontal position, but is activated as shown in the diagram on page 1.
- When the liquid level falls, the contact of the floating switches is activated slightly below the horizontal position.

SM... float switches

The rising or falling liquid level causes the float to move slightly up or down. When the float rises, it activates a microswitch (changeover contact).

versions also available. Detailed information on request.

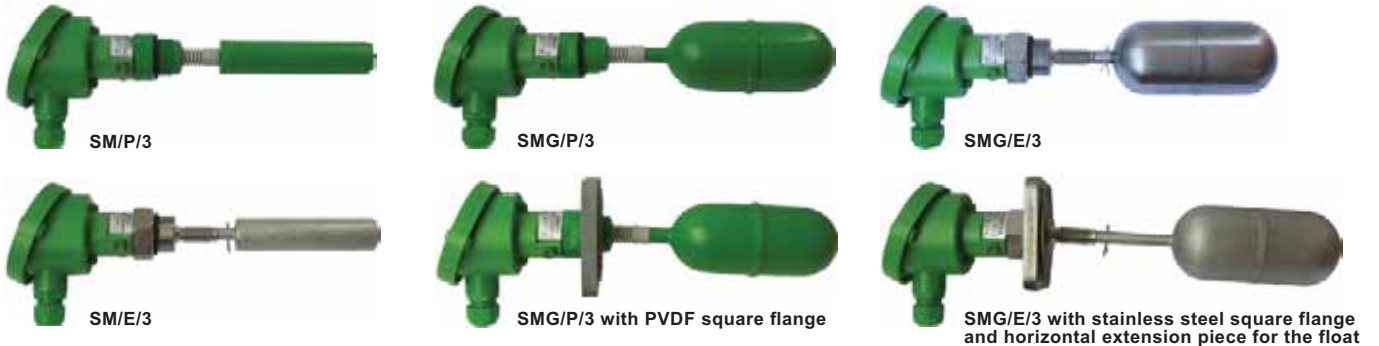

Technical data	SM/P/3	SMG/P/3	SM/E/3	SMG/E/3
Application	for applications up to max. 250 V			
Switching voltage	between AC/DC 24 V and AC/DC 250 V			
Switching current	between AC 20 mA and AC 5 (1) A			
Switching capacity	or between DC 20 mA and DC 100 mA max. 1,000 VA			
Operating principle	microswitch, changeover contact			
Bellows material	PP	PP	stainless steel 316 Ti	stainless steel 316 Ti
Float material	cylindrical float	cylindrical float	cylindrical float	cylindrical float
Float dimensions	Ø 29 mm x 133 mm long	Ø 63 mm x 140 mm long; on request: ball float Ø 85 mm	Ø 28 mm x 120 mm long	Ø 63 mm x 140 mm long on request: ball float Ø 95 mm
On request: extension piece for the float	—	—	—	horizontal or vertical
Screw-in nipple	PP, G1	—	—	stainless steel 316 Ti, G1
Flange	PP, PVDF, steel St 37 or stainless steel 316 Ti	—	—	steel St 37 or stainless steel 316 Ti
Float protection class	IP 68			
Connection head	PP with M 20 x 1.5 cable entry, protection class IP 54; on request: connection head made of cast aluminium, protection class IP 54			
Mounting orientation	horizontal			
Temperature application range	from 0°C to + 90°C		from 0°C to + 100°C	
	(inside the connection head: from 0°C to + 60°C)			
Pressure resistance	for pressureless applications			
Test pressure	max. 2 bar at + 20°C (without flange or with flange made of steel or stainless steel; with square flange made of PP or PVDF: 0 bar)		—	
Application	≥ 0.82 g/cm ³	only for use in liquids with a specific gravity ≥ 0.7 g/cm ³		≥ 0.7 g/cm ³ (without extension piece)

SM/P/3

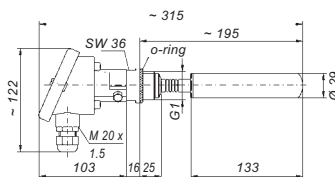

SMG/P/3

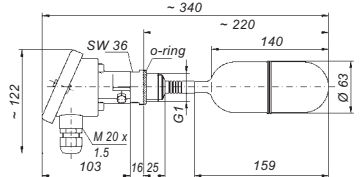

SM/E/3

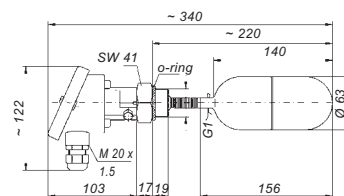
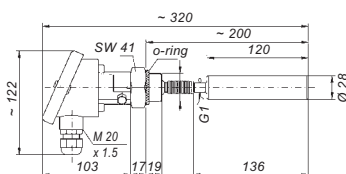

SMG/E/3

TSR... immersion probes

Magnetically operated liquid level controllers

versions also available.
Detailed information on request.

The TSR immersion probes have a probe tube with built-in monostable reed contacts. The float is fitted with a permanent ring magnet and moves freely up and down the probe tube, activating the reed contacts as it rises and falls.

It should be noted that monostable reed contacts do **not** lock but that they switch only for as long as they are influenced by the magnetic field.

Once the float passes beyond a contact upwards or downwards, the latter returns to its original position. However, the contacts can be made to hold by using collars to limit the motion of the float.

For use outside potentially explosive atmospheres, the customer can choose between the models TSR/3/... and TSR/1/...:

Models	TSR/3/...	TSR/1/...
Application	for standard applications	for light current applications
Switching voltage	AC/DC 24 V - 250 V	AC/DC 1 V - 42 V
Switching current	AC 100 mA - 2 A (0.4 A)	AC 1 mA - 500 mA
Switching capacity	max. 100 VA	max. 20 VA

Also available with angled probe tube for mounting from the side.

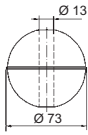
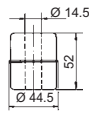
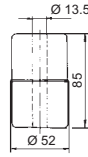
Technical data	TSR./ED/E 1	TSR./ED/E 2	TSR./ED/E 3
Probe tube material		stainless steel 316 Ti	
Probe tube diameter		12 mm	
Probe tube length		according to customer specifications	
Screw-in nipple		G ¹ / ₂ , on request G1, G1 ¹ / ₂ or G2;	
Float	Ø 73 mm (ball)  ≥ 0.7 g/cm ³	on request with reducing nipple made of malleable cast iron G/R1 ¹ / ₂ conical stainless steel 316 Ti, Ø 44.5 mm x 52 mm high (mounting through a G1 ¹ / ₂ socket possible)  ≥ 0.95 g/cm ³	on request with reducing nipple made of malleable cast iron G/R2 conical or cast steel G2 stainless steel 316 Ti, Ø 52 mm x 85 mm high (mounting through a G2 socket possible)  ≥ 0.7 g/cm ³
Float suitable for use in media with a specific gravity			
Terminal box		PP, A 307, 120 x 80 x 55 mm, protection class IP65	
Mounting orientation		vertical	
Admissible temperature range taking into account the probe tube length		from - 20°C to + 100°C	
- max. 2,000 mm			
- max. 1,500 mm			
- max. 1,000 mm			
- max. 750 mm			
- max. 500 mm			
- max. 400 mm			
Pressure resistance at + 20°C		max. 12 bar, higher pressure resistance on request	
Contacts		reed contacts: make (NO), break (NC) or changeover (OC) contacts	
Max. number of contacts		3	
Max. number of contacts when the probe tube is fitted with an inner tube			
Min. distances (based on liquids with a specific gravity of 1 g/cm ³):			
- from the nipple sealing surface to the upper contact		80 mm	80 mm
- between contacts		80 mm	80 mm
- from the lower contact to the end of the probe tube (when float is falling)		60 mm	75 mm

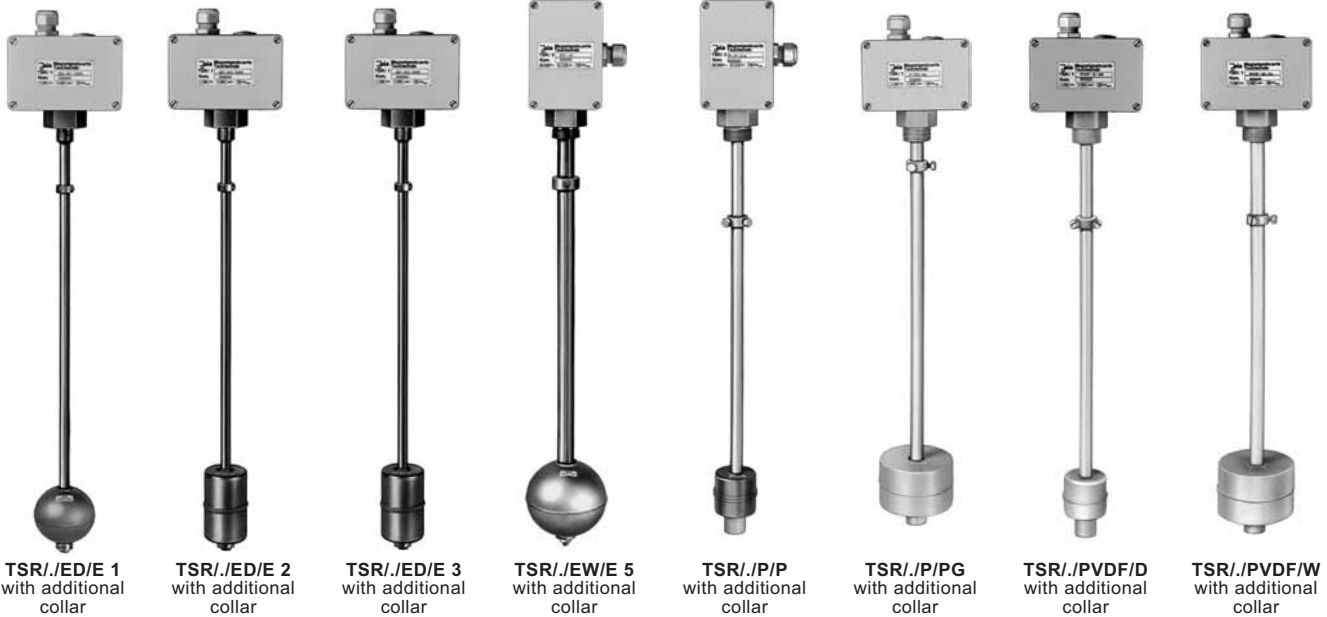

TSR./ED/E 1 with additional collar

TSR./ED/E 2 with additional collar

TSR./ED/E 3 with additional collar

TSR./EW/E 5 with additional collar

TSR./P/P with additional collar

TSR./P/PG with additional collar

TSR./PVDF/D with additional collar

TSR./PVDF/W with additional collar

TSR./EW/E 5

TSR./P/P

TSR./P/PG

TSR./PVDF/D

TSR./PVDF/W

20 mm

14 mm

16 mm

14 mm

16 mm

max. approx. 1,000 mm | max. approx. 2,000 mm | max. approx. 1,000 mm | max. approx. 2,000 mm
 according to customer specifications, but taking into account the max. temperature in the tank and possible liquid turbulence

G1, on request G2

G1, on request G1½ or G2; on request with reducing nipple made of malleable cast iron 1½ or 2 conical or cast steel G2

Ø 97 mm (ball) or Ø 97 mm x 80 mm high (heat-resistant version)

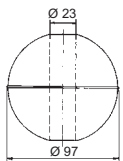

≥ 0.7 g/cm³

Ø 53 mm x 50 mm high (mounting through a G2 socket possible)

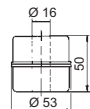

≥ 0.8 g/cm³

PP, Ø 90 mm x 60 mm high

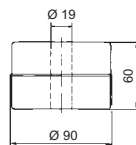

≥ 0.8 g/cm³

Ø 53 mm x 50 mm high (mounting through a G2 socket possible)

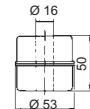

≥ 1 g/cm³

PVDF, Ø 90 mm x 60 mm high

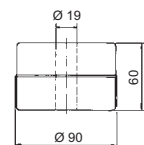

≥ 1 g/cm³

IP 65, with max. 12 terminals; other terminal boxes on request; with connecting cable on request

vertical

100°C; 0°C to + 130°C

—

from 0°C to + 50°C
 from 0°C to + 60°C
 from 0°C to + 75°C
 from 0°C to + 80°C

—

from 0°C to + 40°C
 from 0°C to + 45°C
 from 0°C to + 55°C
 from 0°C to + 70°C
 from 0°C to + 80°C
 from 0°C to + 80°C

max. 2 bar

reed contacts: make (NO), break (NC) or changeover (OC) contacts

6, more on request

3

6

3

6

—

3

—

3

80 mm

80 mm

80 mm

80 mm

80 mm

80 mm

60 mm

55 mm

75 mm

HMW/3/.. and HMW/1/.. magnetic switches

These magnetic switches have a housing which can be fastened to a pipe by means of a clamp which is attached to the housing. The housing contains a connection terminal and a microswitch; a magnet is fixed to the lever of the latter. When the magnetic switch is installed and the magnet on the microswitch lever is activated by a magnet moving up or down in the pipe, this changes the position of the lever and actuates the microswitch.

The magnetic switches have a so-called bistable characteristic; i.e. they remain in the switching status caused by the influence of the passing magnet and only switch over when the magnet passes by in the opposite direction.

These units are not suitable for use on vibrating machines or on tanks exposed to the risk of shock or vibration.

Technical data	HMW/3/..	HMW/1/..
Function	changeover contact	
Characteristic	bistable	
Application	for standard applications	for light current applications
Switching voltage	between AC/DC 24 V and AC/DC 250 V	between AC/DC 1 V and AC/DC 42 V
Switching current	between AC 20 mA and AC 3 (1) A or between DC 20 mA and DC 100 mA	between AC 0.1 mA and AC 100 (50) mA or between DC 0.1 mA and DC 10 mA
Switching capacity	max. 500 VA / 10 W	max. 4 VA / 0,4 W
Housing	PP, approx. 65 x 50 x 35 mm	
Protection class	IP 65	
Clamp material and clamp diameter (suffix to type designation)	28 = with stainless steel clamp for pipe with outer Ø of 28 mm 32 = with PP clamp, on request stainless steel clamp, for pipe with outer Ø of 30 to 32 mm 40 = with stainless steel clamp for pipe with outer Ø of 35 to 40 mm 60 = with stainless steel clamp for pipe with outer Ø of 50 to 70 mm	
Mounting orientation	vertical (cable entry must point downwards)	
Temperature application range	from + 1°C to + 60°C	



HMW/1/32 magnetic switch, attached to a transparent pipe made of PVC containing a float made of PP

versions also available. Detailed information on request.

HA/... level indicators

The HA/... level indicators allow direct read-off of a liquid level based on the system of communicating tubes in the sightglass of the unit.

The unit is fitted with 3 taps (2 taps to separate the unit from the tank, 1 tap for discharge of the liquid).

The HMW/3/32 and HMW/1/32 magnetic switches can be attached to the transparent pipe of the HA/... level indicator. In this case, a float made of PP with a built-in magnet must be inserted in the tube.

Technical data	HA/E 32	HA/PP
Tap material	stainless steel 316 Ti	PP
Sightglass material	Duran glass; on request: transparent PVC	
Dimensions of connecting flanges	DN 32 PN 6 or DN 32 PN 10/16, other dimensions on request	DN 32 PN 6,
Centre distance	as required, max. 1,500 mm, longer on request	
Outer diameter of sightglass	32 mm	
Discharge tap	3/8"	
Mounting orientation	vertical	
Temperature application range	from + 1°C to + 60°C, other temperature ranges on request	
Pressure resistance	for pressureless applications	



HA/PP with float made of PP and 2 magnetic switches

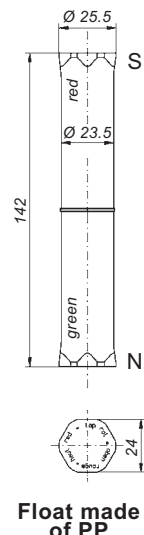

Float made of PP

NVM/PP/. level controllers

Magnetically operated liquid level controllers

These level controllers are fitted with a float, a float rod and a magnet.

The float follows the level of the liquid and moves the float rod of the unit up or down. Above the nipple a guide tube is attached for the float rod and the magnet. Adjustable HMW/.32 magnetic switches are mounted on the outside of the tube.

These magnetic switches have a so-called bistable characteristic; i.e. they remain in the switching status caused by the influence of the passing magnet and only switch over when the magnet passes by in the opposite direction.

These units are not suitable for use on vibrating machines or on tanks exposed to the risk of shock or vibration.

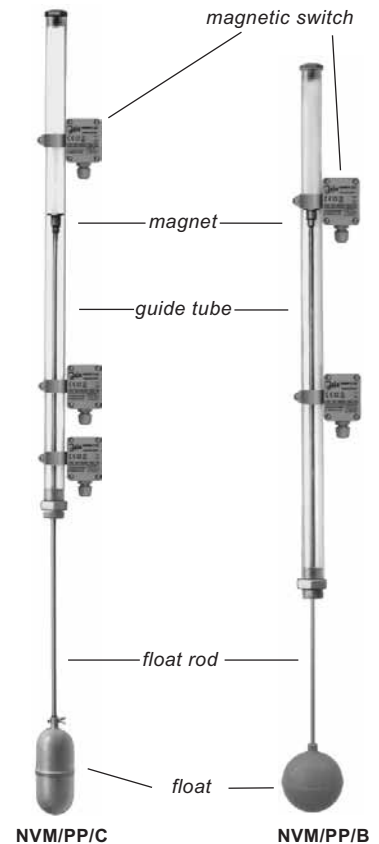

Technical data	NVM/PP/C	NVM/PP/B
Float material	PP	
Float dimensions	Ø 63 mm x 140 mm high	Ø 85 mm (ball)
Float rod diameter	6 mm	
Float rod material	stainless steel 316 Ti or titanium	
Float rod length	as required, measured from the nipple sealing surface and without float (dimension L)	
Max. length of the float rod for liquids with a specific gravity of 1 g/cm ³ (dimension L)	700 mm 1,200 mm	800 mm 1,200 mm
	max. lengths for other specific gravities on request	
Magnet capsule material	PP	
Screw-in nipple material	PP, on request: stainless steel 316 Ti	
Screw-in nipple dimension	G1	
Option: installation flange for mounting of the unit from outside the tank	square flange made of PP, PVDF, steel or stainless steel	flange DN 100 or bigger made of any material
Float rod bushing material	POM; PTFE on request	
Guide tube material	transparent PVC	
Guide tube dimensions	Ø 32 mm x L + 65, other lengths on request	
Mounted magnetic switches	HMW/3/32 or HMW/1/32	
Max. number of magnetic switches	as required and according to the guide tube length	
Mounting orientation	vertical	
Temperature application range	from +1°C to +60°C	
Pressure resistance	for pressureless applications only	
Option	chemical protection, consisting of: - shrinkdown tubing made of PVDF covering the float rod (float rod length up to max. 500 mm), - PP adapter between rod and float, - float rod bushing piece made of PTFE instead of POM	

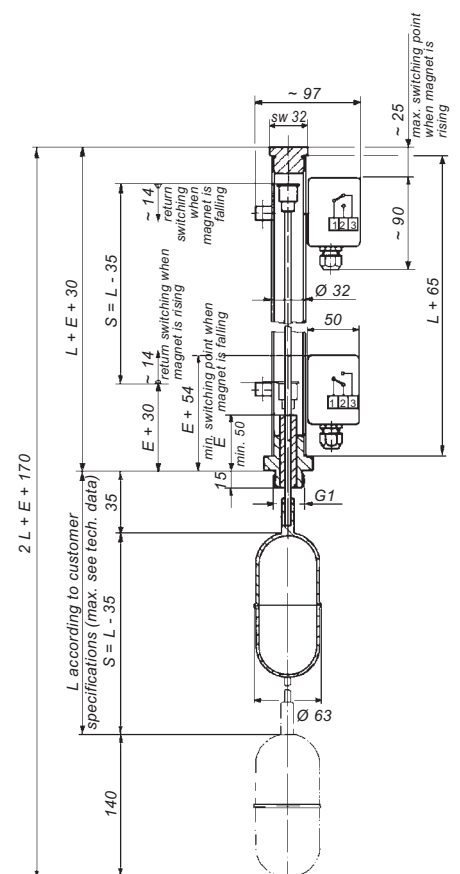

Controllers for conductive liquids

Operating principle

These controllers are used for the automatic control of pumps or solenoid valves as well as for overflow or run-dry protection in wells or tanks with electrically conductive liquids. The liquid levels are monitored by electrodes which give switching commands to the electronic relay depending on contact with the liquid.

For two-point control, two control electrodes and one earth electrode are required. Signalling of one liquid level requires one control electrode and one earth electrode. A metallic, conductive tank wall can be used as an earth connection in place of the earth electrode. **However, we recommend the use of a separate earth electrode.**

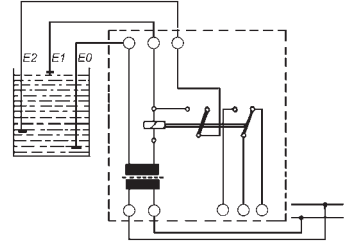

Circuit diagram:
E0 = earth electrode,
E1 and E2 = control electrodes

versions also available. Detailed information on request.

Suspension electrodes

Technical data	EH	EHK	LWZ	EHE
Design	1 control electrode or 1 earth electrode		1 control electrode and 1 earth electrode	
Electrode rod(s)		stainless steel	316 Ti	
Housing	PP	PP	PP and Duroplast	stainless steel
Insulators	Ø 27 mm x ~ 145 mm long	Ø 27 mm x ~ 145 mm long	2 x Ø 27 mm x ~ 210 mm long	Ø 28 mm x ~ 70 mm long
Electrical connection	connection terminal	electrode cable 1 x 1.5	electrode cable 2 x 1	electrode cable 2 x 1
Mounting orientation			1 m, longer on request	
Temperature application range			vertical	
Pressure resistance				



Rod electrodes

with G^{1/2} screw-in nipple made of metal

Technical data	SE 1 A	1/2"-15-30
Design	1 control electrode or 1 earth electrode	
Electrode rod	stainless steel 316 Ti, Ø 4 mm, covered with polyolefin shrinkdown tubing as required (measured from nipple sealing surface)	stainless steel 316 Ti, Ø 4 mm, covered with polyolefin shrinkdown tubing as required (measured from nipple sealing surface)
Length		30 mm
Min. length		
Max. length		approx. 2,500 mm
Insulators	cast resin and polyolefin shrinkdown tubing	aluminium oxide and polyolefin shrinkdown tubing
Screw-in nipple	stainless steel 316 Ti, G ^{1/2}	galvanized steel, G ^{1/2}
Electrical connection	special angled plug for H07RN-F 1 x 1 mm ² , protection class IP 34	special angled plug for H07RN-F 1 x 1 mm ² , protection class IP 34
Mounting orientation		vertical
Temperature application range	from + 1°C to + 80°C	from + 1°C to + 80°C
Pressure resistance	max. 10 bar at + 20°C	max. 15 bar at + 20°C



Rod electrodes

with G1 screw-in nipple made of stainless steel 316 Ti

Technical data	S 2 A	S 2 AM	S 3 AM	S 4 AM	S 5 AM
Design	2 control electrodes	1 control electrode and 1 earth electrode	2 control electrodes and 1 earth electrode	3 control electrodes and 1 earth electrode	4 control electrodes and 1 earth electrode
Electrode rods	stainless steel 316 Ti, Ø 4 mm, covered with polyolefin shrinkdown tubing as required (measured from nipple sealing surface)				
Lengths	approx. 2,500 mm				
Max. lengths	polyolefin shrinkdown tubing and cast resin				
Insulators	stainless steel 316 Ti, G1				
Screw-in nipple	stainless steel 316 Ti, G1				
Electrical connection	PP connection head with M 20 x 1.5 cable entry, protection class IP 54; on request: aluminium connection head, protection class IP 54				
Mounting orientation	vertical				
Temperature application range	from + 1°C to + 80°C				
Pressure resistance	max. 10 bar at + 20°C				



NR 3 and NR 5/G electrode relays

for level control or for signalling a limit level

Electrode relay for U-bar mounting, with connection terminals on top of housing and with 2 built-in LEDs for signalling the switching status.

Electrode relay in surface-mount housing, with transparent cover and with 2 built-in LEDs (inside the housing) for signalling the switching status



This unit is designed for switch cabinet mounting or installation in a suitable protective housing only and may therefore only be mounted/installed in these locations. It is suitable for use in clean environments only.

Technical data	NR 3	NR 5/G
Alternative supply voltages	AC versions: terminals 10 and 12; DC versions: terminal 10: –, terminal 12: +	AC versions: terminals 1 and 2; DC versions: terminal 1: –, terminal 2: +
Power input	approx. 3 VA	
Electrode circuit	terminals 4, 5, 6	terminals 6, 7, 8
– no-load voltage	9 V _{eff} 10 Hz	9 V _{eff} 10 Hz
– short-circuit current	max. 0.5 mA _{eff}	
– response sensitivity	approx. 30 kΩ or approx. 33 μS (electric conductance)	
Controlled circuit	terminals 7, 8, 9, 1 single-pole potential-free changeover contact based on the quiescent current principle	terminals 3, 4, 5, 1 single-pole potential-free changeover contact based on the quiescent current principle
Switching status indicators	1 green LED, lights when output relay is energized 1 red LED, lights when output relay is not energized	
Switching voltage	max. AC 250 V	
Switching current	max. AC 4 A	
Switching capacity	max. 500 VA	
Housing	insulating material, 75 x 22.5 x 100 mm	insulating material, 130 x 94 x 57 mm, with 3 cable entries
Connection	terminals on top of housing	internal terminals
Protection class	IP 20	IP 54
Mounting orientation	clip attachment for U-bar to DIN 46 277 and EN 50 022	surface mounting using 4 screws
Temperature application range	from – 20°C to + 60°C	
Mounting orientation	any	
Max. cable length between electrode relay and electrode(s)	1,000 m	
EMC	for interference emission in accordance with the appliance-specific requirements for households, business and commerce as well as small companies, and for interference immunity in accordance with the appliance-specific requirements for industrial companies.	

For the detection of conductive liquids (e.g. water, ...): Plate electrodes and cable electrodes

For signalling the presence of a conductive liquid caused, for example, by a burst pipe.

Plate and cable electrodes can, for example, be used on normally dry floors or false ceilings or in normally dry pipeline and cable ducts.

Cable electrodes can also be used alongside pipes or in double-pipe systems.

If the two electrode plates of a plate electrode or the two sensor cables of a cable electrode come into contact with a conductive liquid (e.g. water, acid etc.), an electrical contact is made and an alarm signal given.

Leakage detectors for conductive and non-conductive liquids also available. See page 14.

versions also available. Detailed information on request.

PE, PE-Z10, PEK and PEK-Z10 plate electrodes

These leakage detectors are also available in versions for direct connection to a PLC, a small-scale control system, a DDC controller or a field bus coupling element. Detailed information on request.



PE or PE-Z10
plate electrode,
sensor side



PE-Z10
plate electrode,
connection side



PEK-Z10
plate electrode,
connection side

Application example

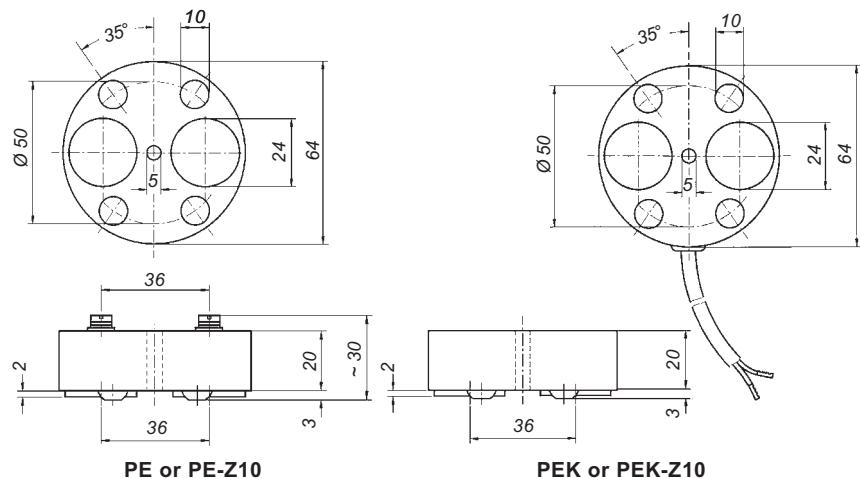
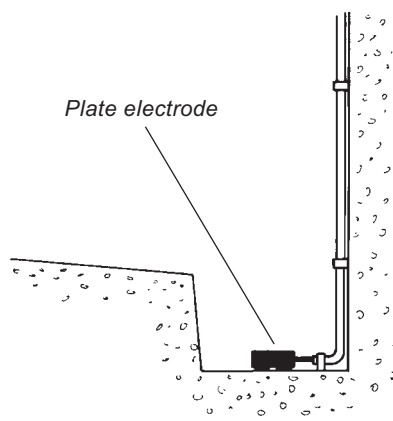

Technical data	PE	PE-Z10	PEK	PEK-Z10
Design	1 control electrode and 1 earth electrode			
Electrode plate material	stainless steel 316 Ti			
Housing	PP and cast resin			
Electrical connection	screw-type / crimp connection		connecting cable 2 x 0.75, length 2 m, longer cable on request; halogen-free connecting cable on request	
Temperature application range	from - 20°C to + 60°C, higher temperatures on request			
Cable break monitoring	without	with	without	with
		integrated Z10 cable break monitoring unit		
Max. length of connecting cable between PE-Z10 or PEK-Z10 and electrode relay	1,000 m			

The PE and PEK plate electrodes may only be connected to the Leckstar 5 electrode relay.

Only one PE-Z10 or one PEK-Z10 plate electrode or a plate electrode combination consisting of one or more PE + one PE-Z10 or consisting of one or more PE + one PEK-Z10 may be connected to the Leckstar 101 electrode relay. The connection must be made as shown in the circuit diagrams on page 13.

KE and KE-Z10 cable electrodes

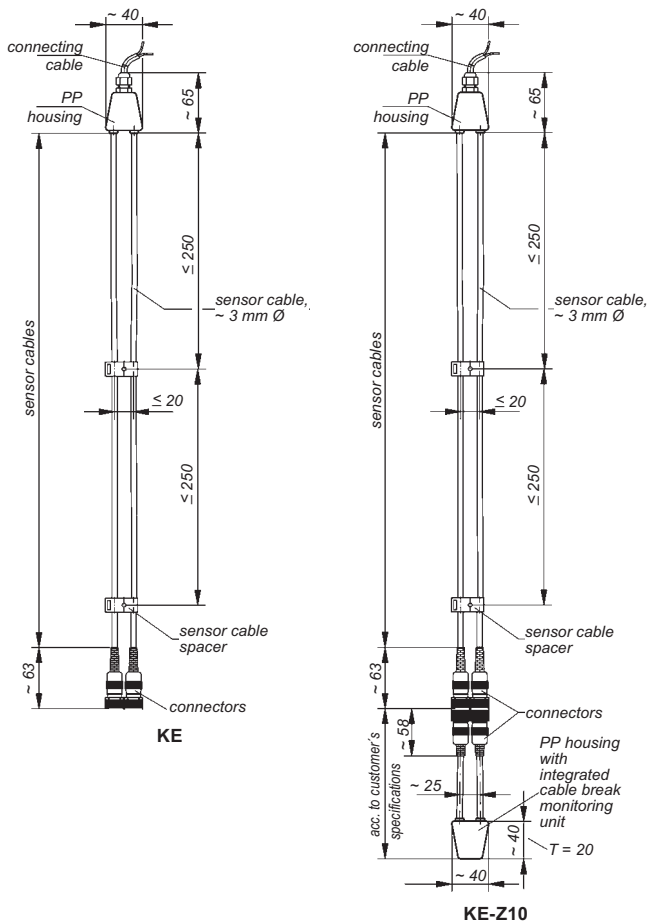

These leakage detectors are also available in versions for direct connection to a PLC, a small-scale control system, a DDC controller or a field bus coupling element. Detailed information on request.

Application example

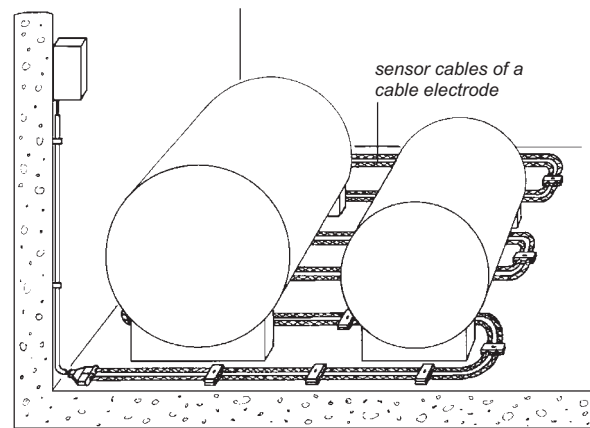

KE-Z10

Technical data	KE	KE-Z10
Design	1 control electrode and 1 earth electrode	
Sensor cables	2 ropes made of stainless steel 316 or 316 Ti, each 3 mm in dia., each covered by a halogen-free protective polyester sheath; length: 2 m each, longer on request	
Max. length of sensor cables when laid in a relatively straight line	100 m; if the sensor cables are wound round a pipe or tank, the possible lengths may be considerably shorter depending on the type and method of laying.	
Supplied mounting accessories	4 sensor cable spacers made of PP per metre of sensor cable	
Electrical connection	connecting cable 2 x 0.75, length: 2 m; longer cable on request; halogen-free connecting cable on request	
Temperature application range	from - 20°C to + 60°C	
Cable break monitoring	without	with
	integrated Z10 cable break monitoring unit to monitor the connecting cable and the sensor cables	
Max. length of connecting cable between cable electrode and electrode relay	1,000 m minus the length of the sensor cable pair	

Notice for the mounting of the cable electrode

The 2 sensor cables of the cable electrode must be mounted parallel to one another at a distance of approx. 2 cm using the sensor cable spacers, as a greater or lesser spacing affects the response level of the system in the event of leakage.

The KE cable electrode may only be connected to the Leckstar 5 electrode relay.

The KE-Z10 cable electrode may only be connected to the Leckstar 101 electrode relay.

Leckstar 5 and Leckstar 101 electrode relays

Electrode relays for U-bar mounting, with connection terminals on top of housing, with switchable self-hold function and with built-in LED(s) for signalling the operating status.

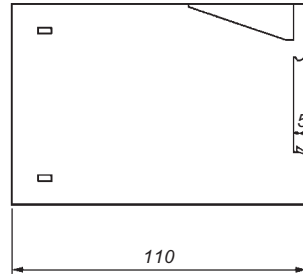
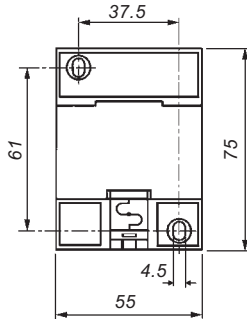

The units are designed for switch cabinet mounting or installation in a suitable protective housing and may therefore only be mounted/installed in these locations. They are suitable for use in clean environments only.



Self-hold:

- If the switch for self-hold is switched on, an alarm is stored. The relay continues to signal the alarm even if the cause of the alarm (e.g. the presence of water or a cable break) is no longer present - in other words, if the sensor is dry again or if the line has contact. The alarm is acknowledged by switching off the switch for self-hold.
- If the switch for self-hold is not switched on, the alarm is not maintained when the cause of the alarm has been remedied.

Technical data	Leckstar 5	Leckstar 101
Alternative supply voltages (AC versions: terminals 15 and 16; DC versions: - terminal 15: -, - terminal 16: +)	- AC 230 V supplied if no other supply voltage is specified in the order) or - AC 240 V or - AC 115 V or - AC 24 V or - DC 24 V or } only for connection to a safety low voltage which corresponds - DC 12 V or } to the safety regulations relating to the application - further supply voltages on request	
Power input Electrode connection (terminals 7 and 8)	approx. 3 VA 2 terminals under SELV (safety extra low voltage) acting on 1 output relay with switchable self-hold 18 V _{eff} 10 Hz SELV (safety extra low voltage) max. 0.5 mA _{eff} approx. 30 kΩ or approx. 33 μS (electric conductance)	
- no-load voltage - short-circuit current - response sensitivity - Cable break monitoring	via Zener diode (Z10) circuit at the end of the sensor line (incorporated in the PE-Z10, PEK-Z10 or KE-Z10 electrode)	
Controlled circuit (terminals 9, 10 and 11) Switching status indicators	1 single-pole potential-free changeover contact based on the quiescent current principle - red LED permanently lit: leakage alarm, output relay not energized - yellow LED flashing: cable break, output relay not energized - green LED permanently lit: OK status, output relay energized - red LED permanently lit: leakage alarm, output relay not energized	
Switching voltage Switching current Switching capacity Housing Connection Protection class Mounting Temperature application range Mounting orientation Max. length of connecting cable between electrode relay and Z10 cable break monitoring unit EMC	max. AC 250 V max. AC 4 A max. 500 VA insulating material, 75 x 55 x 110 mm terminals on top of housing IP 20 clip attachment for U-bar to DIN 46 277 and EN 50 022 from - 20°C to + 60°C any	
	1,000 m for interference emission in accordance with the appliance-specific requirements for households, business and commerce as well as small companies, and for interference immunity in accordance with the appliance-specific requirements for industrial companies.	

Leckstar 101 circuit diagrams (position of contacts when Leckstar ... without voltage)

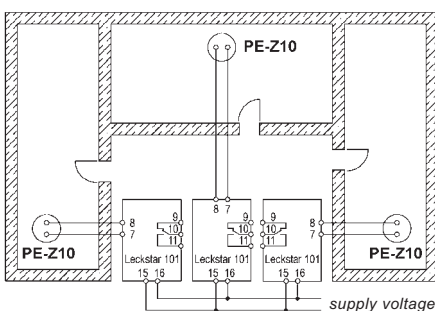

Connection of several plate electrodes to several Leckstar 101 electrode relays - separate alarms

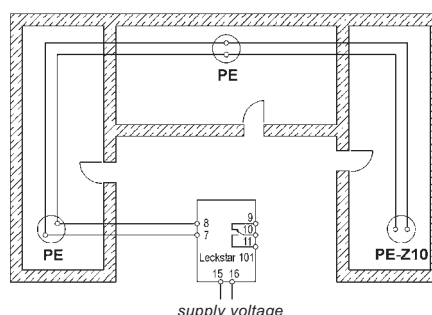

Connection of several plate electrodes to one Leckstar 101 electrode relay - group alarm

For the detection of **conductive** (e.g. water, ...) and **non-conductive liquids** (e.g. oils, ...):

COW/L and OWE 2/C sensors

Ex versions also available. Detailed information on request.

Technical data	COW/L	OWE 2/C
Housing	stainless steel 316 Ti and PTFE, Ø 28 mm x approx. 145 mm high	PP and cast resin, 74 mm x 46 mm x 76 mm high
Connecting cable	oil-resistant PVC cable 2 x 0.75 mm ² , length 5 m, longer cable on request	capacitive sensor with stainless steel cylindrical capacitor
Functional principle	capacitive sensor with stainless steel cylindrical capacitor	capacitive sensor with gold-plated capacitor plates on epoxy resin backing material
Self-capacitance	CEq = 80 nF + 0.2 nF per metre of connecting cable	
Self-inductance	Leq = 0 + 1 µH per metre of connecting cable	
Protection class for the electronics sealed in the housing	IP 65	
Temperature application range	from - 20°C to + 60°C	
Response height from bottom edge of housing	approx. 12 mm (depending on the dielectric constant of the liquid)	
Mounting accessory	stand made of stainless steel 316 Ti	
Max. length of connecting cable between sensor and relay	1,000 m, longer on request	
EMC	for interference emission in accordance with the appliance-specific requirements for households, business and commerce as well as small companies, and for interference immunity in accordance with the appliance-specific requirements for industrial companies.	



COW/L



OWE 2/C

Leckmaster 101 relay

with cable break monitoring and switchable self-hold, for connection of a COW/L or OWE 2/C sensor

Technical data	Leckmaster 101
Alternative supply voltages (AC versions: terminals 15 and 16; DC versions: - terminal 15: -, - terminal 16: +)	<ul style="list-style-type: none"> - AC 230 V (supplied if no other supply voltage is specified in the order) or - AC 240 V or - AC 115 V or - AC 24 V or - DC 24 V or - DC 12 V or only for connection to a safety low voltage which corresponds to the safety regulations relating to the application - further supply voltages on request
Power input	approx. 3 VA
Control circuit (terminals 6 and 8)	2 terminals under SELV (safety extra low voltage), acting on 1 output relay with switchable self-hold
Sensor connection (in line with EN 50 227):	DC 8.4 V SELV (safety extra low voltage)
- no-load voltage	< 10 mA
- short-circuit current	1.5 mA \perp 1.8 mA
- response sensitivity	I < 0.15 mA
Cable break monitoring	1 single-pole potential-free changeover contact based on the quiescent current principle
Controlled circuit (term. 9, 10, 11)	3 LEDs (see below)
Switching status indicators	max. AC 250 V
Switching voltage	max. AC 4 A
Switching current	max. 500 VA
Switching capacity	insulating material, 75 x 55 x 110 mm
Housing	terminals on top of housing
Connection	IP 20
Protection class	clip attachment for U-bar to DIN 46 277 and EN 50 022
Mounting	from - 20°C to + 60°C
Temperature application range	any
Mounting orientation	1,000 m, longer on request
Max. connecting cable length between sensor and relay	for interference emission in accordance with the appliance-specific requirements for households, business and commerce as well as small companies, and for interference immunity in accordance with the appliance-specific requirements for industrial companies.
EMC	



Position of the output contact of the Leckmaster 101 relay

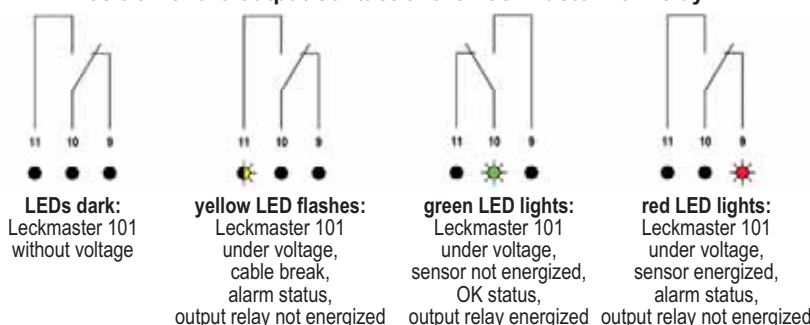

Leckmaster 101 connection diagram (position of the contact when Leckmaster 101 without voltage)

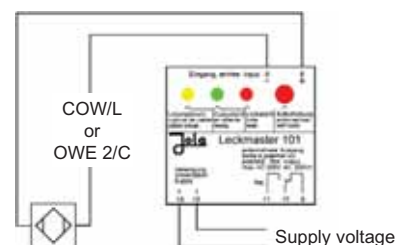

Floating electrodes

for detection of a thin layer of non-conductive liquids with a lower specific gravity on top of conductive liquids with a higher specific gravity, e.g. oil on water

Ex versions also available.
Detailed information on request.

Design

The SCHE ... floating electrodes are made up of an upper section and a lower section. The upper section consists of an electrode holder and a rod electrode (whose position can be adjusted in the electrode holder) with one control electrode and one earth electrode for alarm signalling. The lower section of the floating electrode is made up of four floats and a stabilising plate.

Mode of operation and adjustment

The SCHE ... floating electrode normally floats on a conductive liquid, such as water. It is connected to an electrode relay which supplies it with a low safety voltage. The height of the rod electrode is set in such a way that the two electrode rod tips are permanently underwater. Depending on the movement of the surface of the liquid, the rod electrode should be set further up or down. Although the two electrode rod tips should be permanently underwater, they should only just be underwater, so that when a conductive liquid (water in our example) is overlaid by a non-conductive liquid (such as oil), a thin layer of the non-conductive liquid (oil) is sufficient to lift the electrode rod tips of the rod electrode from the conductive water layer into the non-conductive oil layer, to thus interrupt the current flowing from the electrode relay via the rod electrode, and therefore to activate an alarm.

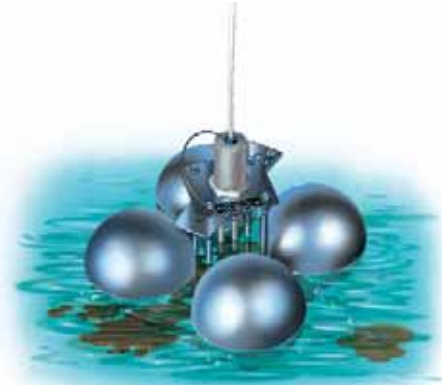

If, for example, oil flows onto a still water surface following a leak, exact setting of the rod electrode will ensure that an oil layer of only approx. 5 to 10 mm thickness is sufficient to interrupt the control current flowing via the rod electrode and activate an alarm.

To ensure functioning of the SCHE ... floating electrode, there must be a minimum liquid level of 80 mm to 130 mm (depending on model) above the floor. If this condition is not fulfilled, the two electrode rod tips will no longer be underwater – in other words, they will not be electrically bridged by a conductive liquid. This will lead to normally undesired alarm activation via the connected electrode relay. The only model with an alarm bridging contact for this eventuality is the SCHE 2/E (Variante ILS).

The SCHE ... floating electrodes are designed for connection to the electrode relay ESA 2.

SCHE ... floating electrodes

Technical data	SCHE 2/T/GR	SCHE 2/E	SCHE 2/E (Variante ILS)
Design	1 control electrode and 1 earth electrode		
Electrode rods	stainless steel 316 Ti, Ø 4 mm, coated with shrinkdown tubing made of polyolefine		
Electrode head	PP	stainless steel 316 Ti	
Connection	oil-resistant PVC cable,	PTFE cable,	
Length of connecting cable	potted in electrode head; other cable on request		
Material of electrode holder, stabiliser plate and brackets	PVC	stainless steel 316 Ti or other stainless steel	
No. of floats, float material and float dimensions	PP approx. 85 mm Ø	4 units made of stainless steel 316 Ti approx. 95 mm Ø	stainless steel 316 Ti approx. 130 mm Ø
Alarm bridging contact	—	—	magnetically activated reed contact
Temperature application range	from + 8°C to + 60°C	from – 20°C to + 90°C	
Max. length of connecting cable between relay and SCHE ...	1,000 m		

ESA 2 relay

Technical data	ESA 2
Alternative supply voltages	see relay Leckstar on page 13
Electrode circuit (terminals 7 and 8)	2 terminals with SELV (safety extra low voltage), acting on 2 relays without self-hold, where one can be reset if an alarm is activated
– no-load voltage	9 V _{eff} 10 Hz SELV (safety extra low voltage)
Controlled circuits (terminals 12, 13 - relay 1, terminals 9, 10 - relay 2)	2 potential-free normally closed contacts based on the quiescent current principle, both activated in standby status. One of the two normally closed contacts (terminals 12, 13 - relay 1) can be reset in the event of alarm. The other normally closed contact (terminals 9, 10 - relay 2) retains its switching status as long as the alarm is given.
Acknowledgement	relay 1 (terminals 12, 13) can be reset via a built-in button or an external acknowledgement button (connection option at terminals 4 and 5)
Switching status indicator	via two-colour LED : – green LED permanently lit: OK status, output relays energized, – red LED flashing: leakage alarm, output relays not energized, – red LED permanently lit: output relay 1 energized, output relay 2 not energized
All other technical data	see relay Leckstar on page 13

